

Amandolier building,  
Geneva , Switzerland







## **LINE GRAZER® PLUS**



# LINE GRAZER® PLUS

- Powerful wall washer up to 30m
- Lumens output up to 10500lm
- Antiglare luminaire
- Flush wall washer
- 3 beam angles: 12°, 33° and 39x14°
- Perfect color mixing
- Easy serial connection
- Bañador de paredes potente hasta 30m
- Lumens output hasta 10500lm
- Luminaria antideslumbrante
- Bañado de luz a ras de la luminaria
- 3 ángulos de apertura: 12°, 33° y 39x14°
- Mezcla de colores perfecta
- Fácil conexión en serie

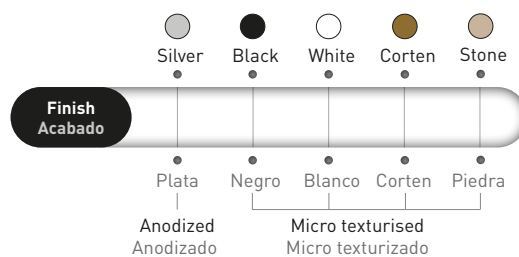
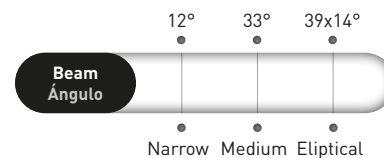
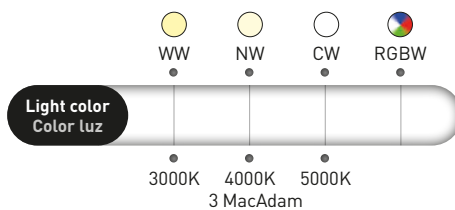
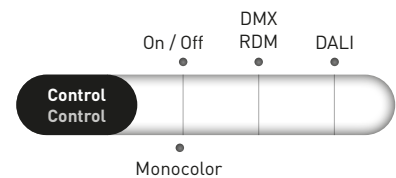
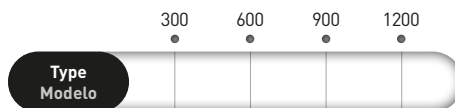
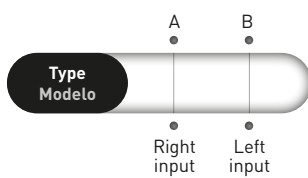

The standard version is delivered with DMX, floor-wall bracket and 39x14° beam angle.  
La versión estándar se suministra con DMX, soporte suelo-pared y un ángulo de apertura de 39x14°.

## SPECIFICATIONS CARACTERÍSTICAS

IP66	IK09	CRI 80	on/off	DMX RDM	DALI	100-277V AC		AL Housing	Security GLASS Cover	Ta -20°C min -4°F Ta +50°C max +122°F	CE
------	------	--------	--------	------------	------	----------------	--	---------------	----------------------------	--	----

Line Grazer® PLUS 1200										
Power	130W (20 LEDs)									
Color temperature	3000K	4000K	5000K	RGBW						
				Red	Green	Blue	4000K	R+G+B+W		
Lumens output	12° - 9824 lm 33° - 8932 lm 39x14 - 9376 lm	12° - 10464 lm 33° - 9512 lm 39x14 - 9988 lm	12° - 10464 lm 33° - 9512 lm 39x14 - 9988 lm	12° - 1100 lm 33° - 1000 lm 39x14 - 1050 lm	1516 lm 1380 lm 1450 lm	308 lm 280 lm 294 lm	1908 lm 1736 lm 1823 lm	4110 lm 3736 lm 3923 lm		
Luminaire efficiency	76 lm/W	80 lm/W	80 lm/W	31 lm/W						
Measures / Weight	1221 x 127 x 72 mm / 8 kg									

Line Grazer® PLUS 900										
Power	97W (15 LEDs)									
Color temperature	3000K	4000K	5000K	RGBW						
				Red	Green	Blue	4000K	R+G+B+W		
Lumens output	12° - 7368 lm 33° - 6699 lm 39x14 - 7032 lm	12° - 7848 lm 33° - 7134 lm 39x14 - 7490 lm	12° - 7848 lm 33° - 7134 lm 39x14 - 7490 lm	12° - 825 lm 33° - 750 lm 39x14 - 788 lm	1137 lm 1035 lm 1087 lm	231 lm 210 lm 220 lm	1431 lm 1302 lm 1368 lm	3081 lm 2802 lm 2942 lm		
Luminaire efficiency	76 lm/W	80 lm/W	80 lm/W	31 lm/W						
Measures / Weight	921 x 127 x 72 mm / 6,1 kg									

Line Grazer® PLUS 600										
Power	65W (10 LEDs)									
Color temperature	3000K	4000K	5000K	RGBW						
				Red	Green	Blue	4000K	R+G+B+W		
Lumens output	12° - 4912 lm 33° - 4466 lm 39x14 - 4688 lm	12° - 5232 lm 33° - 4756 lm 39x14 - 4994 lm	12° - 5232 lm 33° - 4756 lm 39x14 - 4994 lm	12° - 550 lm 33° - 500 lm 39x14 - 525 lm	758 lm 690 lm 724 lm	154 lm 140 lm 147 lm	954 lm 868 lm 911 lm	2025 lm 1868 lm 1962 lm		
Luminaire efficiency	76 lm/W	80 lm/W	80 lm/W	31 lm/W						
Measures / Weight	621 x 127 x 72 mm / 4 kg									

Line Grazer® PLUS 300										
Power	33W (5 LEDs)									
Color temperature	3000K	4000K	5000K	RGBW						
				Red	Green	Blue	4000K	R+G+B+W		
Lumens output	12° - 2456 lm 33° - 2233 lm 39x14 - 2344 lm	12° - 2616 lm 33° - 2378 lm 39x14 - 2497 lm	12° - 2616 lm 33° - 2378 lm 39x14 - 2497 lm	12° - 275 lm 33° - 250 lm 39x14 - 262 lm	379 lm 345 lm 362 lm	77 lm 70 lm 74 lm	477 lm 434 lm 456 lm	1027 lm 934 lm 981 lm		
Luminaire efficiency	76 lm/W	80 lm/W	80 lm/W	31 lm/W						
Measures / Weight	321 x 127 x 72 mm / 1,9 kg									

Color temperature conform to ANSI C78.377A. Temperatura de color según normativa ANSI C78.377A.  
Lumens measurement conform to LM-79-08. Medición lumens según normativa LM-79-08.  
Lumens maintenance conform to LM-80-08. Mantenimiento lumens según normativa LM-80-08.

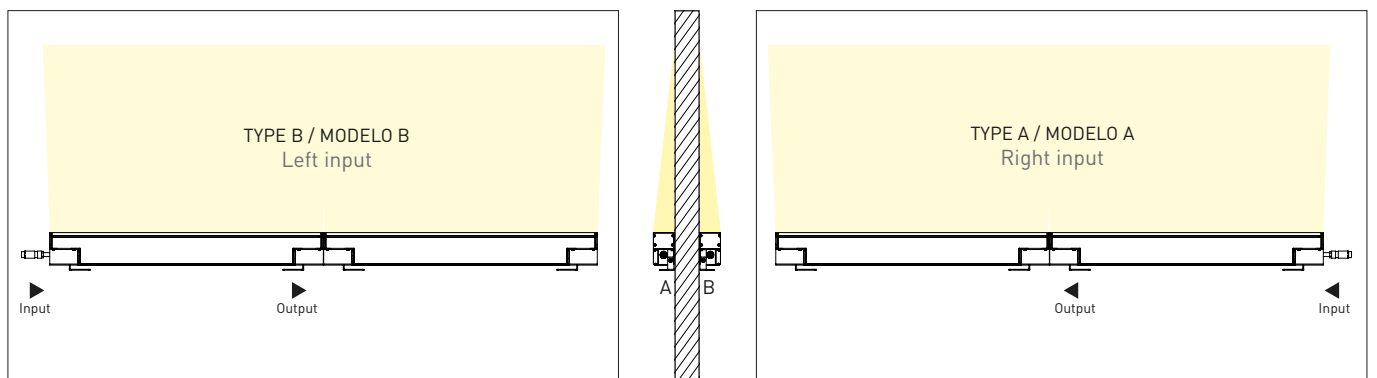

# LINE GRAZER® PLUS

## MEASURES MEDIDAS

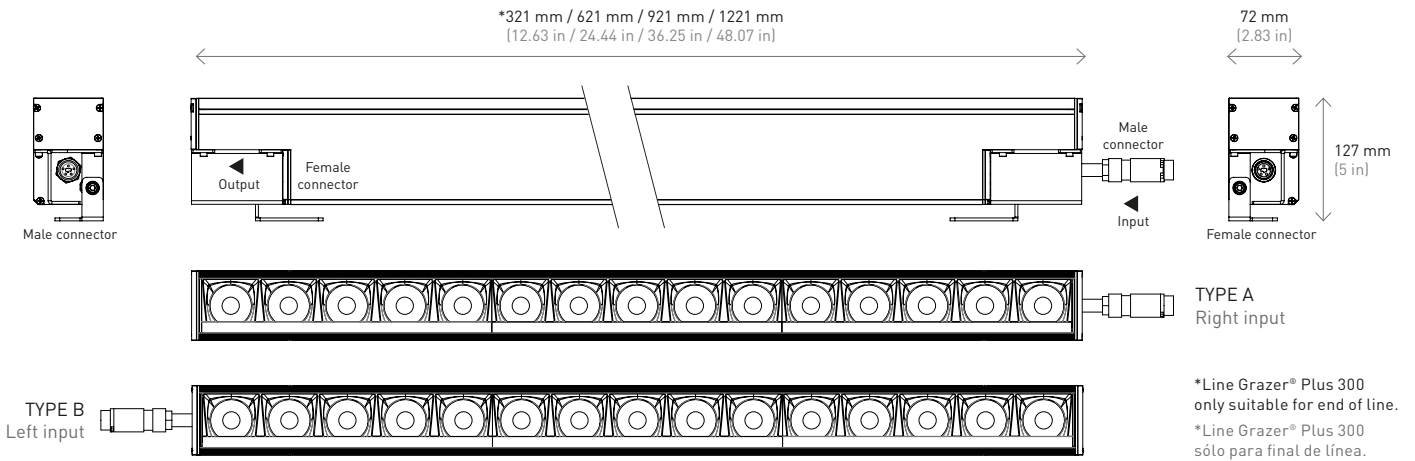

## ROTATION ROTACIÓN

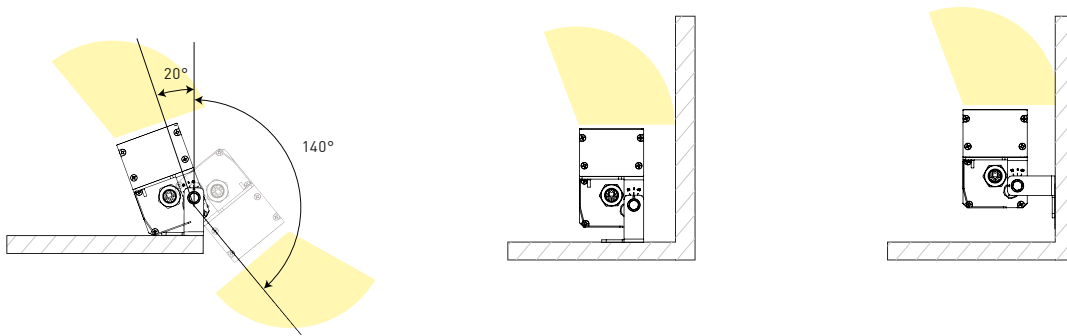

## LIGHT DISTRIBUTION CURVES FOTOMETRÍAS

### Line Grazer® Plus RGBW

33 W 33°

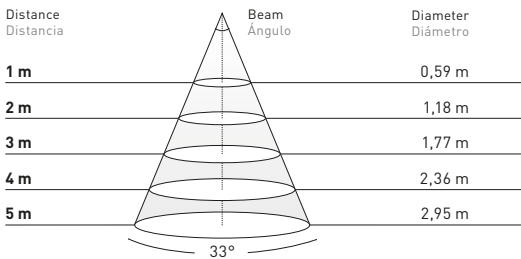

R	G	B	W	R+G+B+W
RED ROJO	GREEN VERDE	BLUE AZUL	WHITE BLANCO	
614 lux	854 lux	172 lux	1094 lux	2341 lux
153 lux	214 lux	43 lux	274 lux	585 lux
68 lux	95 lux	19 lux	122 lux	260 lux
38 lux	53 lux	11 lux	68 lux	146 lux
25 lux	34 lux	7 lux	44 lux	94 lux

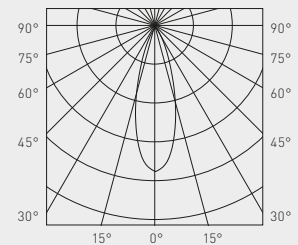

### Line Grazer® Plus

33 W 33°

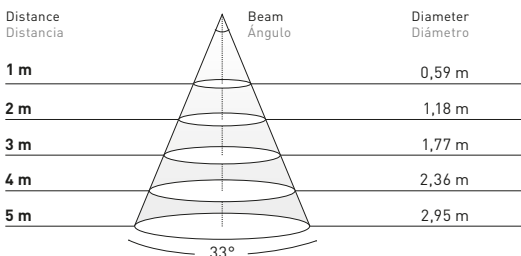

3000K	4000K	5000K
WARM WHITE BLANCO CÁLIDO	NEUTRAL WHITE BLANCO NEUTRO	COOL WHITE BLANCO FRÍO
5522 lux	5880 lux	5880 lux
1380 lux	1470 lux	1470 lux
613 lux	653 lux	653 lux
345 lux	368 lux	368 lux
221 lux	236 lux	236 lux

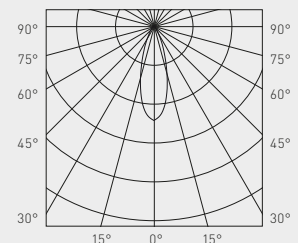

Data calculated with **Line Grazer® Plus (300 mm)**.  
Lumen measurement complies with **UNE-EN 13032 / IES LM-79-08** testing procedures.  
Light distribution curves are available at [www.mclight.com](http://www.mclight.com).  
Due to continuous improvements and innovations, specifications may change without notice.

Datos calculados con **Line Grazer® Plus (300 mm)**.  
Ensayado bajo las especificaciones de la norma **UNE-EN 13032 / IES LM-79-08**.  
Fotometrías disponibles en [www.mclight.com](http://www.mclight.com).  
Debido a las continuas mejoras e innovaciones, las especificaciones pueden cambiar sin previo aviso.



## FINISHES ACABADOS

In order to satisfy all our customers, five different versions are available: silver, black, white, corten and stone.  
Con el fin de satisfacer las necesidades de nuestros clientes, está disponible en cinco acabados: plata, negro, blanco, corten y piedra..



Anodized silver.  
Plata anodizado.



Micro texturised black.  
Negro micro texturizado.



Micro texturised white.  
Blanco micro texturizado.



Micro texturised corten.  
Corten micro texturizado.



Micro texturised stone.  
Piedra micro texturizado.

## DETAILS DETALLES

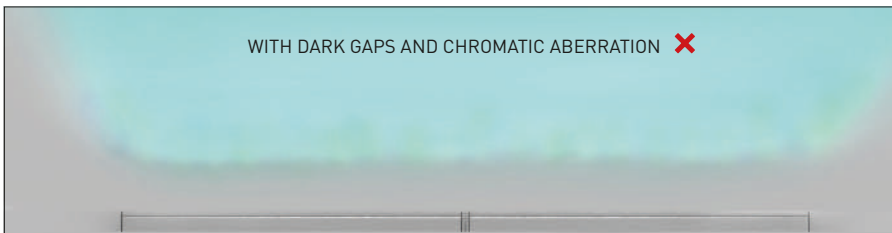

Homogeneous wall washer effect, without dark gaps.  
Bañador de pared uniforme, sin zonas oscuras.

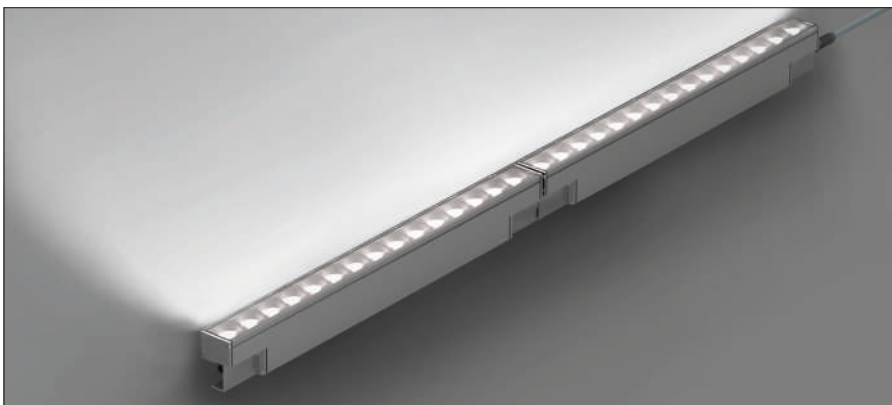

Flush wall washer. Invisible wiring between luminaires.  
Bañado de luz a ras de la luminaria. Cableado oculto entre luminarias.



Antiglare luminaire.  
Luminaria antideslumbrante.

# LINE GRAZER® PLUS

## MONOCOLOR ON-OFF CONNECTIONS CONEXIONES ON-OFF MONOCOLOR

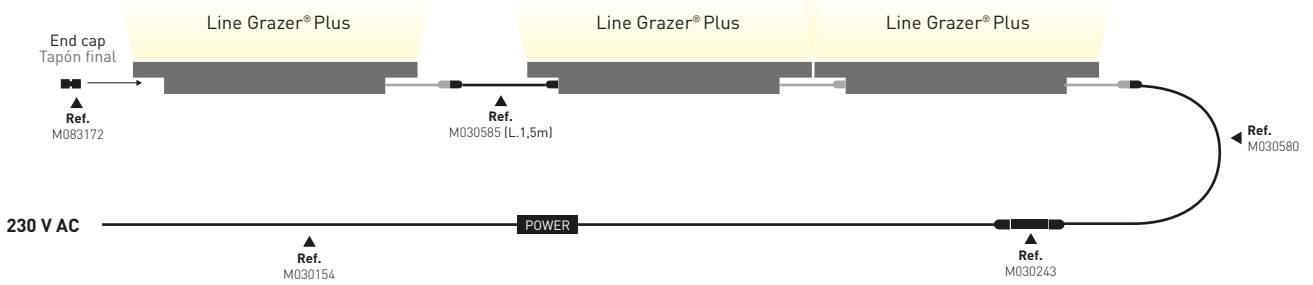

**!** Maximum 8 units of Line Grazer Plus per on-off connection  
Máximo de 8 Line Grazer Plus por conexión on-off

## DMX RDM CONNECTIONS CONEXIONES DMX RDM

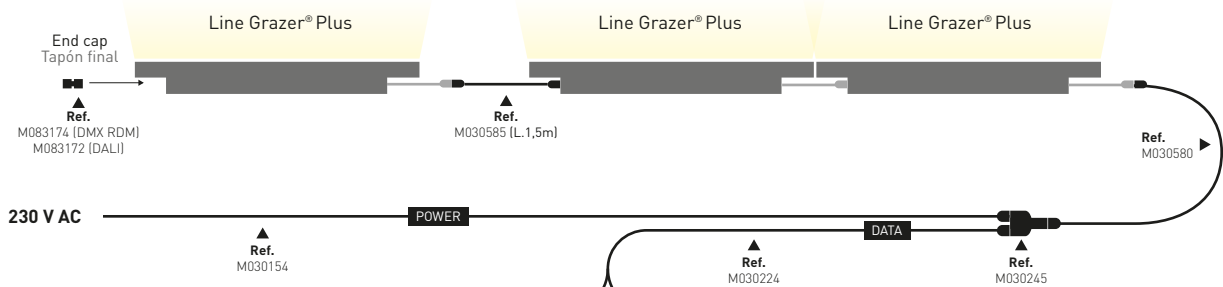

**MORE THAN 8 LINE GRAZER® PLUS WITH DMX RDM.  
PARA MÁS DE 8 LINE GRAZER® PLUS CON DMX RDM.**

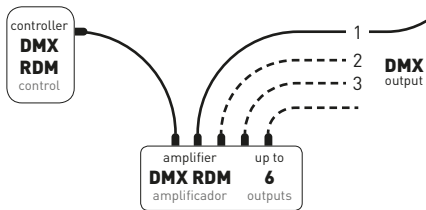

**A**

**MORE THAN 8 LINE GRAZER® PLUS WITH DMX RDM.  
PARA MÁS DE 8 LINE GRAZER® PLUS CON DMX RDM.**

Maximum 8 Line Grazer® Plus per DMX RDM output.  
Maximum 100 meters from controller to the amplifier.  
Maximum 100 meters from amplifier to last Line Grazer® Plus.

Máximo 8 Line Grazer® Plus por salida DMX RDM.  
Máximo 100 metros del controlador al amplificador.  
Máximo 100 metros del amplificador al último Line Grazer® Plus.

**UP TO 8 LINE GRAZER® PLUS WITH DMX.  
HASTA 8 LINE GRAZER® PLUS CON DMX.**



**B**

**UP TO 8 LINE GRAZER® PLUS WITH DMX RDM.  
HASTA 8 LINE GRAZER® PLUS CON DMX RDM.**

Maximum 8 Line Grazer® Plus per DMX RDM controller.  
Maximum 100 meters from controller to last Line Grazer® Plus.  
Follow connection diagram type B for DALI installations.

Máximo 8 Line Grazer® Plus por controlador DMX RDM.  
Máximo 100 metros del controlador al último Line Grazer® Plus.  
Para instalación DALI seguir el conecionado tipo B.

## ACCESSORIES REFERENCES REFERENCIAS ACCESORIOS

1	2	3	4	5	6
					
<b>M030580</b>	2 m power cable (5 poles-female)		Cable alimentación 2 m (5 polos-hembra)		<b>1</b>
<b>M030585</b>	1,5 m extension cable (5 poles)		Cable extensión 1,5 m (5 polos)		<b>2</b>
<b>M083174</b>	120 OHM end cap (5 poles-male) DMX RDM		Tapón final 120 OHM (5 polos-macho) DMX RDM		<b>3</b>
	Custom assembly for installers.		Para el montaje a medida por el instalador.		
<b>M083166</b>	IP68 connector (5 poles-male)		Conector aereo IP68 (5 polos-macho)		
<b>M083173</b>	End cap (male)		Tapón final (macho)		
<b>M083167</b>	IP68 connector (5 poles-female)		Conector aereo IP68 (5 polos-hembra)		
<b>M083172</b>	End cap (female) On-off   DALI		Tapón final (hembra) On-off   DALI		
<b>M030400/C12</b>	2 x AWG22 + 3 x 1,5 mm <sup>2</sup> cable (m)		Cable 2 x AWG22 + 3 x 1,5 mm <sup>2</sup> (m)		
	For installation.		Para instalación.		
<b>M030243</b>	IP68 "I" connection Ø6-13,5mm Tee Tube (3 poles)		Conexión "I" Ø6-13,5mm IP68 Tee Tube (3 polos)		<b>4</b>
<b>M030245</b>	IP68 "Y" connection Ø6-17mm Tee Tube (5 poles)		Conexión "Y" Ø6-17mm IP68 Tee Tube (5 polos)		<b>5</b>
<b>M030154</b>	3 x 1,5 mm <sup>2</sup> H07RN-F cable (m)		Cable 3 x 1,5 mm <sup>2</sup> H07RN-F (m)		
<b>M030224</b>	BELDEN 3105A cable (m)		Cable BELDEN 3105A (m)		
<b>7150203</b>	DMX Addresser Setup		DMX Addresser Setup		<b>6</b>

## REFERENCES REFERENCIAS

75510 X X /XX/XX

### COLOR COLOR

/80/3K 3000K  
/80/4K 4000K  
/80/5K 5000K  
/11-4K RGBW

### TYPE MODELO

1	300*	Type A
2	600	
3	900	
4	1200	Type B
6	300*	
7	600	
8	900	
9	1200	

### FINISHES ACABADOS

0	Anodized silver	Plata anodizado
2	Texturised black	Negro texturizado
3	Texturised white	Blanco texturizado
4	Texturised corten	Corten texturizado
5	Texturised stone	Piedra texturizado

\* Line Grazer® Plus 300 only suitable for end of the line.  
Line Grazer® Plus 300 sólo para final de línea.

## OPTIONS OPCIONES

The standard version is delivered with:  
DMX, floor-wall bracket and 39x14° beam angle.

La versión estándar se suministra con:  
DMX, soporte suelo-pared y un ángulo de apertura de 39x14°.

### CONTROL CONTROL

on/off (monocolor)  
DMX RDM (Standard)  
DALI

### BEAM ÁNGULO

12°  
33°  
39x14° (Standard)